



MediaTek LinkIt™ Smart 7688 Get Started Guide

Version: 0.92
Release date: November 2015

Specifications are subject to change without notice.

© 2015, 2016 MediaTek Inc.

This document contains information that is proprietary to MediaTek Inc.
Unauthorized reproduction of this information in whole or in part is strictly prohibited.

Document Revision History

Revision	Date	Description
0.92	Nov 2015	Closed beta release

Table of Contents

- 1. Get Started With the LinkIt™ Smart 7688 Development Platform..... 5**
 - 1.1. Get the Hardware and Software 5
 - 1.2. Sign into the LinkIt Smart 7688 development boards Web UI 6
 - 1.3. Update Your Board’s Firmware 10
 - 1.4. Access the LinkIt Smart 7688 System Console through SSH12
 - 1.5. Run the Blink Example 15
 - 1.6. Connecting to the Internet..... 16
- 2. What’s Next? 19**
 - 2.1. LinkIt Smart 7688 Developer’s Guide..... 19
 - 2.2. LinkIt Smart 7688 Tutorials 19
 - 2.3. Sseed Studio Starter Tutorial..... 19
 - 2.4. Hackster.io 19

Lists of tables and figures

Figure 1 Providing power to the LinkIt Smart 7688 board	7
Figure 2 Wi-Fi LED Status	7
Figure 3 Connecting to LinkIt_Smart_7688 AP	8
Figure 4 LinkIt Smart 7688 in AP mode.....	9
Figure 5 LinkIt Smart 7688 Web UI Set Password	10
Figure 6 LinkIt Smart 7688 firmware upgrade.....	11
Figure 7 Selecting firmware file and start upgrade.....	12
Figure 8 Firmware version.....	12
Figure 9 SSH access using Windows	13
Figure 10 PuTTY Security Warning	14
Figure 11 System console window.....	14
Figure 12 Change networking setting in Web UI.....	16
Figure 13 Changing to Station mode in Web UI.....	17
Figure 14 LinkIt Smart 7688 in Station Mode.....	18
Figure 15 LinkIt Smart 7688 in Station mode connected to a Wi-Fi AP.....	18

1. Get Started With the LinkIt™ Smart 7688 Development Platform

Welcome to the LinkIt Smart 7688 development platform quick start guide, this guide is based on using Windows with examples created in Python, however the same steps apply to Mac and Linux and for node.js — unless specifically noted otherwise.

1.1. Get the Hardware and Software

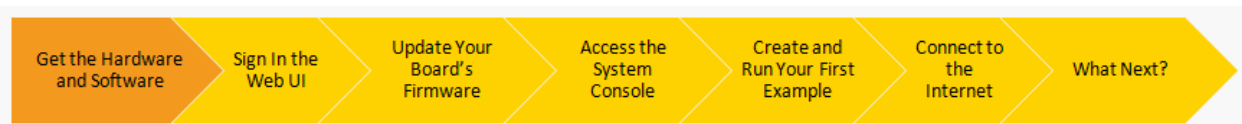

This section describes the hardware and software you need to get started. Before you start, please make sure you've the following items ready:

- A computer with Wi-Fi
- An access point that is connected to the Internet. The AP should have either open access (requires no password) or WPA/WPA2 encryption. APs that require Web-based authentication are not supported
- A micro-USB cable

Quick steps:

- [Buy a LinkIt Smart 7688 development board](#)
- Install [PuTTY](#) for Microsoft Windows (For Windows only)
- Install [Bonjour print service](#) (For Windows 7 only) to use local domain `mylinkit.local`

Next: Sign into the LinkIt Smart 7688 development boards Web UI.

Step-by-step

Step 1: Get Your LinkIt Smart 7688 Development Board

Purchase the LinkIt Smart7688 development board from a distributor such as [Seeed Studio](#).

Step 2: Install PuTTY (For Windows only)

[PuTTY](#) provides you with the system console environment using Secure Socket Shell (SSH) access to the development board's operating system.

Step 3: Install Bonjour Print Service (For Windows 7 only)

The LinkIt Smart 7688 development board uses `mylinkit.local` as its local domain. In Windows 7, you'll need to install the [Bonjour print service](#) because mDNS is not supported. This helps your computer discover the LinkIt Smart 7688's IP address within the local domain. For Windows 8 and later, Mac OS X and Linux, mDNS is supported and you can use `mylinkit.local` without additional software.



If you are using a virtual machine, please note that mDNS may have problems reaching the guest OS network. In this case, please use the host OS browser for the next step – sign into the board's Web UI.

1.2. Sign into the LinkIt Smart 7688 development boards Web UI



Now power up your board, connect a USB power source or your PC to it and open the board's Web UI, which you'll use in subsequent steps to configure your board.

Quick steps:

- Power up your board
- Search for LinkIt_Smart_7688 AP and connect the board through Wi-Fi
- Sign into the LinkIt Smart 7688 Web UI

Next: Update Your Board's Firmware.

Step-by-step

Step 1: Power up your board with a micro-USB cable

Plug in one end of a Micro USB cable to the power connector of the LinkIt Smart 7688 and the other end of the cable to a USB power source, such as your computer as shown in Figure 1, or a USB power adaptor. Make sure you connect the cable to the Power (PWR) connector, not the USB host (HOST) connector near the MPU reset button. The Power LED (Green) will light up solid first followed by the Wi-Fi LED (Red) which will blink once per second. Then, after about 5 seconds, the Wi-Fi LED will light on solid; this indicates that the boot loader has initialized.



Figure 1 Providing power to the LinkIt Smart 7688 board

After boot loader initialization, the boot up process begins, which takes about 30 seconds. Next, the Wi-Fi LED turns off; this means the system is ready to accept a Wi-Fi connection. Figure 2 shows how the Wi-Fi LED status matches the system state.

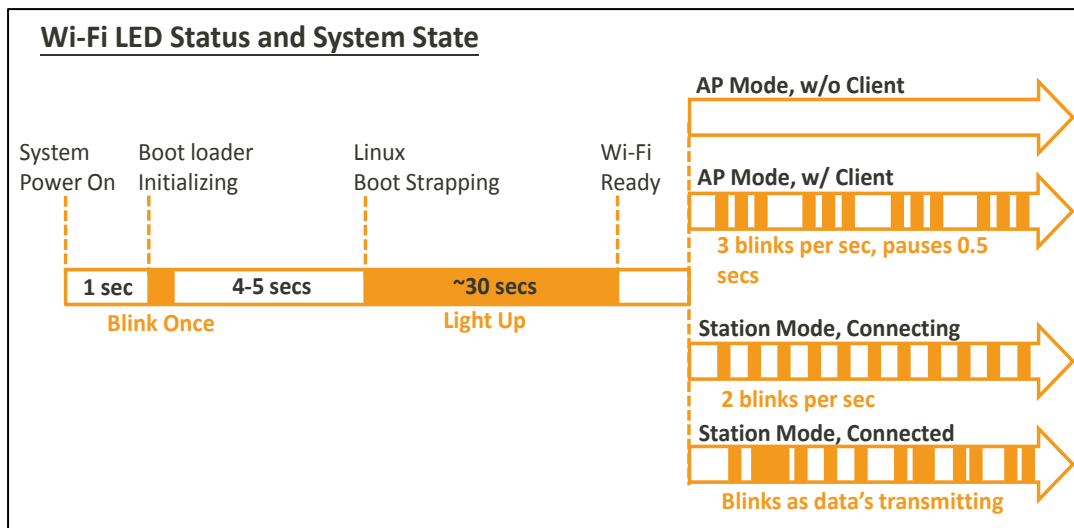

Figure 2 Wi-Fi LED Status

Step 2: Connect your PC to the LinkIt_Smart_7688 AP

Open the Wi-Fi connection utility on your computer and connect to the access point named LinkIt_Smart_7688, as shown in Figure 3.

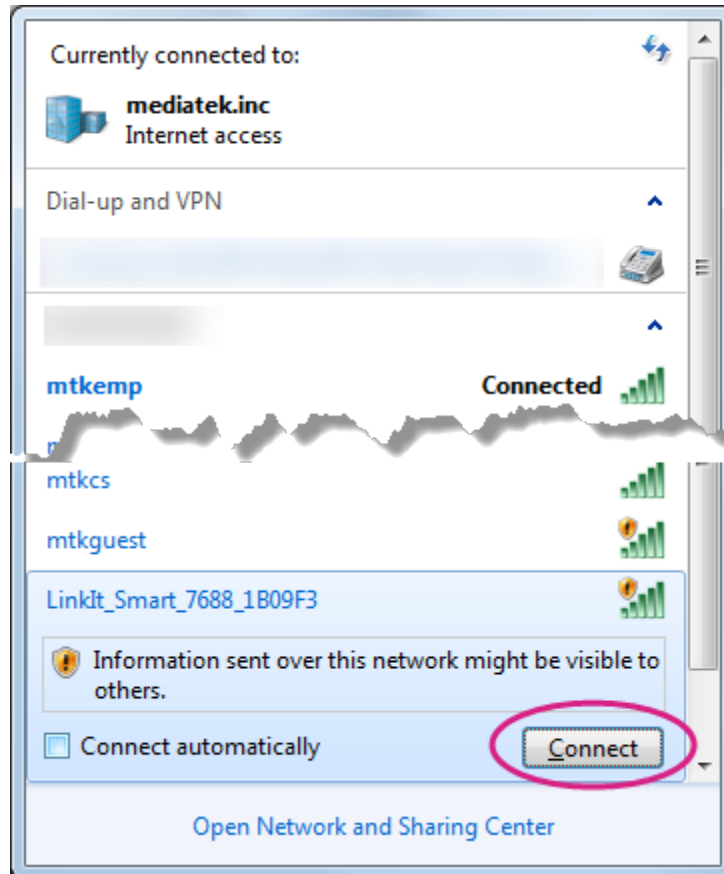

Figure 3 Connecting to LinkIt_Smart_7688 AP

The red LED will blink three times per second after you've connected to the LinkIt_Smart_7688 AP.



If you have multiple LinkIt Smart 7688 boards, power only one of them to prevent a name collision. An alternative is to insert a micro SD card with a file that will change the name of the access point after the board has booted up.

Keep in mind that once you've connected to LinkIt Smart 7688, your computer may no longer have access to the internet – it's now joining the Local Area Network formed by LinkIt Smart 7688, as shown in Figure 4.

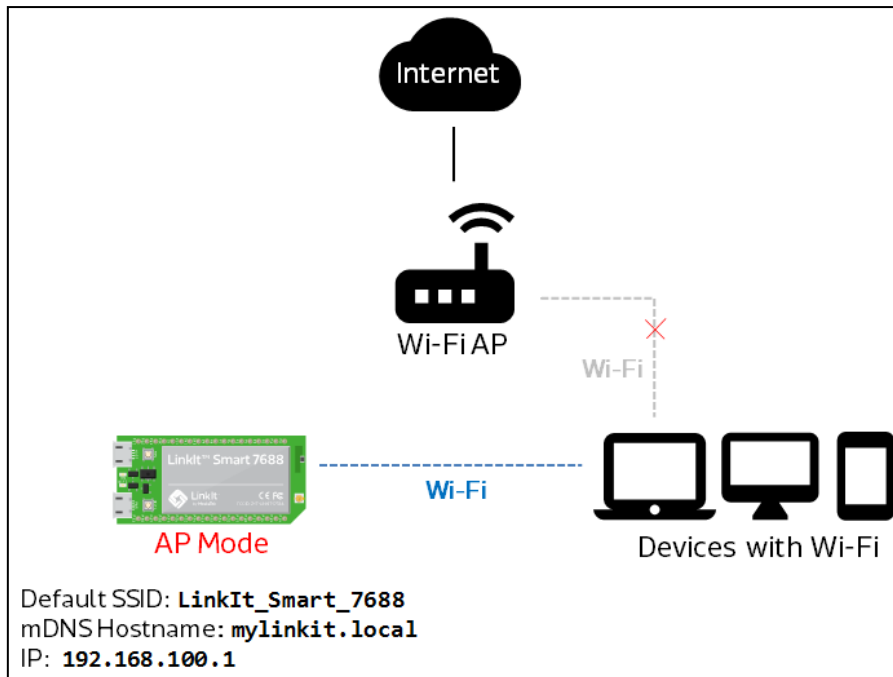

Figure 4 LinkIt Smart 7688 in AP mode

You'll learn how to connect LinkIt Smart 7688 to the Internet in later steps. But first, you need to configure the board.

Step 3: Access the LinkIt Smart 7688 Web UI configuration tools

You now setup the LinkIt Smart 7688 Web UI, a tool for configuring the settings of you board.

- 1) In your web browser open <http://mylinkit.local>, as shown Figure 5.

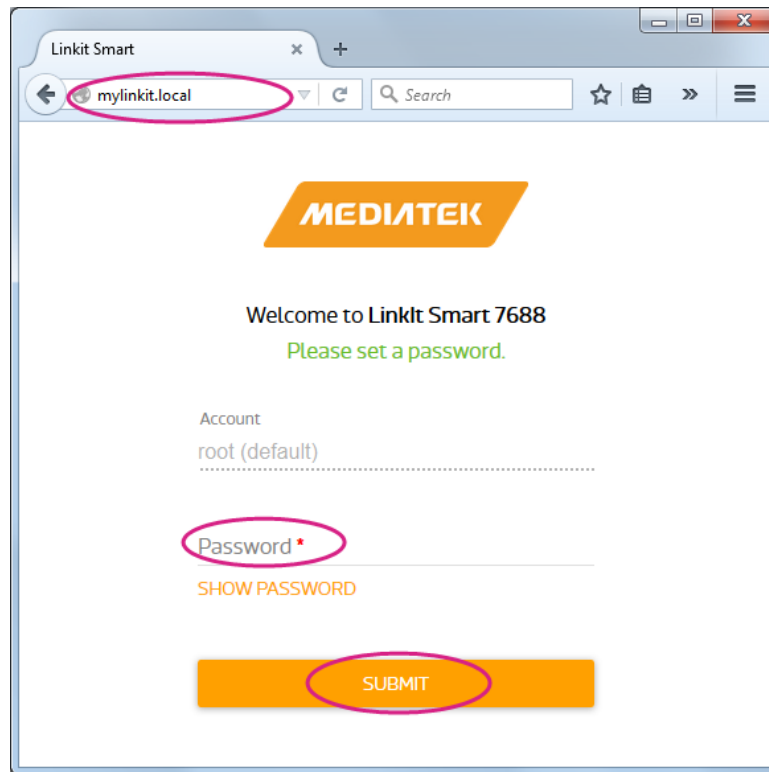

Figure 5 LinkIt Smart 7688 Web UI Set Password

- 2) Set a password using at least 6 alphanumeric characters and click **Submit**. Enter the password again and click **Sign In**.



If the board already has a password and you don't remember it, use a USB drive to upgrade the firmware or press and hold the Wi-Fi button for at least 20 seconds and release to return the board to the factory defaults. Keep in mind if you use either of these methods, it will restore to board's default settings and all user data will be removed from the device. For more information on how to upgrade firmware using a USB drive or use the buttons please refer to LinkIt Smart 7688 Developer's Guide.

1.3. Update Your Board's Firmware

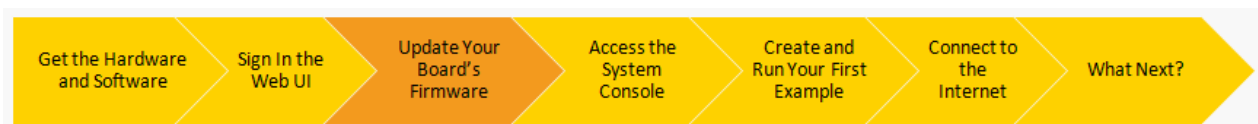

The MediaTek Labs website has the latest firmware for your LinkIt Smart 7688 development board. It is recommended that you upgrade the firmware of your new board to ensure you have the latest version. This section describes how.

Quick steps:

- Install LinkIt Smart 7688 SDT
- Upgrade LinkIt Smart 7688 firmware using Web UI

Next: Access the LinkIt Smart 7688 System Console through SSH.

Step-by-step

Step 1: Install LinkIt Smart 7688 SDT

- 1) The latest LinkIt Smart 7688 SDT from the MediaTek Labs website includes the firmware, bootloader, and toolchain you need to develop applications for LinkIt Smart 7688. Download and unzip the SDT into a permanent location on your computer, such as `D:\{SDT package}`.
- 2) Note the location of the firmware file `lks7688.img`, for example:
`D:\{SDT package}\lks7688.img`

Step 2: Run the LinkIt Smart 7688 Firmware Updater Application

- 1) In the Web UI home page, click **Upgrade Firmware**, as shown Figure 6:

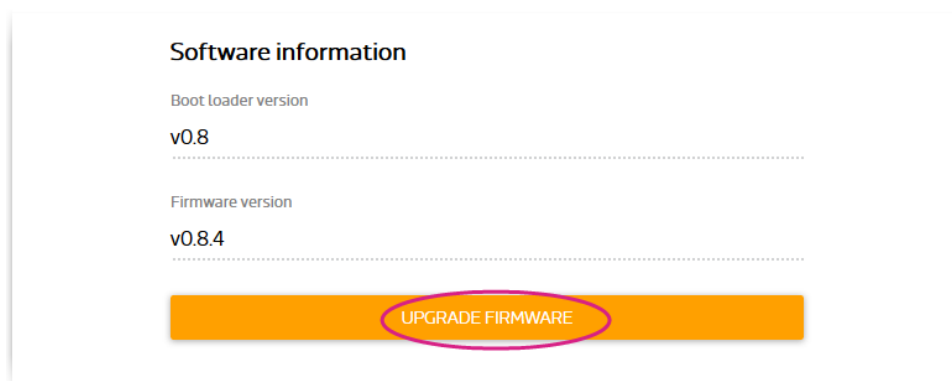

Figure 6 LinkIt Smart 7688 firmware upgrade

- 2) Click **Choose the file** and select the `lks7688.img` file then click **Upgrade & Restart** as shown Figure 7.

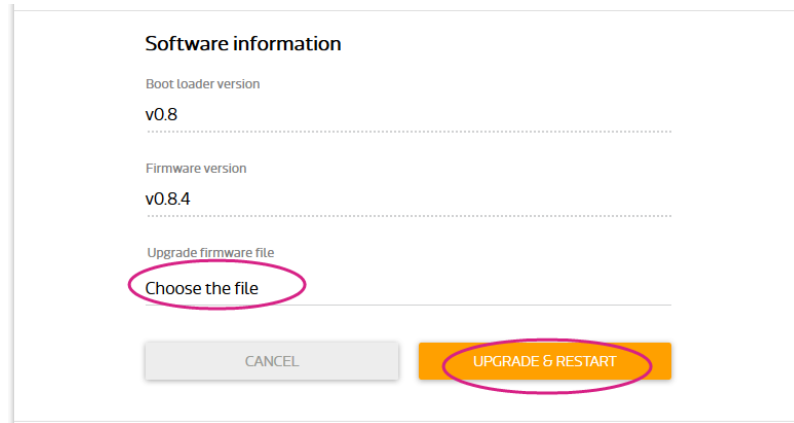

Figure 7 Selecting firmware file and start upgrade

- 3) The firmware uploads to your board. Please make sure the board stays connected to its power source until the firmware upgrade is completed. Notice the Wi-Fi LED blinks for about 3 minutes (firmware upgrading), then the board will restart and the LED lights on for about 30 seconds (rebooting). Finally, the board enters AP mode and is ready to be connected.
- 4) Find the LinkIt_Smart_7688 AP and connect the board through Wi-Fi. Notice the Wi-Fi LED blinks 3 times per second after the board is connected to a client device. Now, reload the mylinkit.local webpage, set a new password and sign in. The new firmware version details will be displayed under **Software Information**, as shown Figure 8.

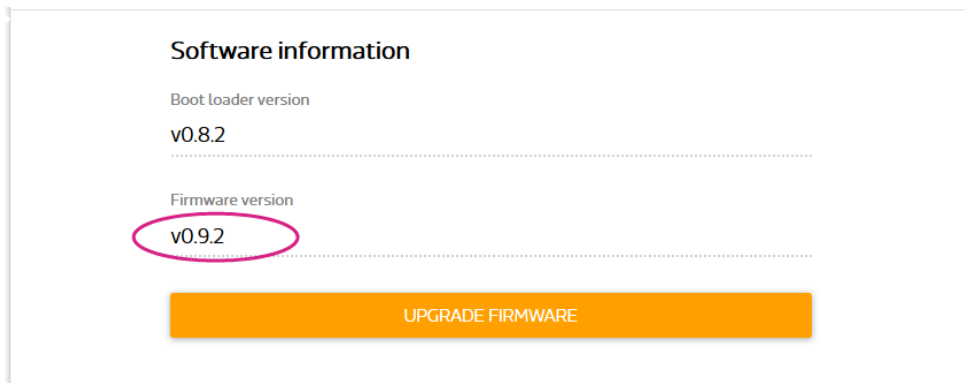

Figure 8 Firmware version

You now have the latest firmware on your LinkIt Smart 7688 development board.

Next: Access the LinkIt Smart 7688 system console using SSH.

1.4. Access the LinkIt Smart 7688 System Console through SSH



LinkIt Smart 7688 system console enables you to enter text commands and get system administration messages.

Quick steps:

- Open your terminal emulator and sign in

Next: Run the Blink Example.

Step 1: Open a Terminal Emulator and Sign in.

On Windows:

- 1) Open PuTTY and in the configuration window, type `mylinkit.local` in **Host Name**, click the **SSH** radio button and then **Open**, as shown Figure 9.

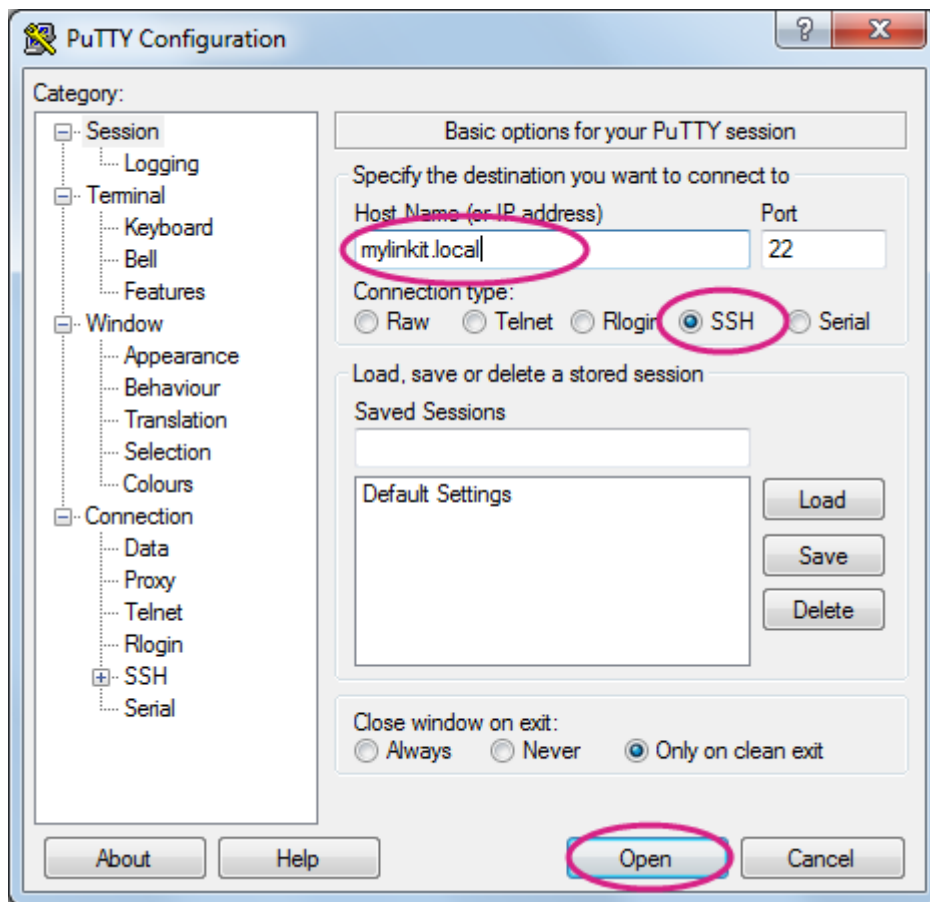

Figure 9 SSH access using Windows

- 2) A Security Alert window will pop up as shown below, this happens when you use PuTTY for the first time, or after upgrading firmware or bootloader, or use a different board. Click **Yes**.

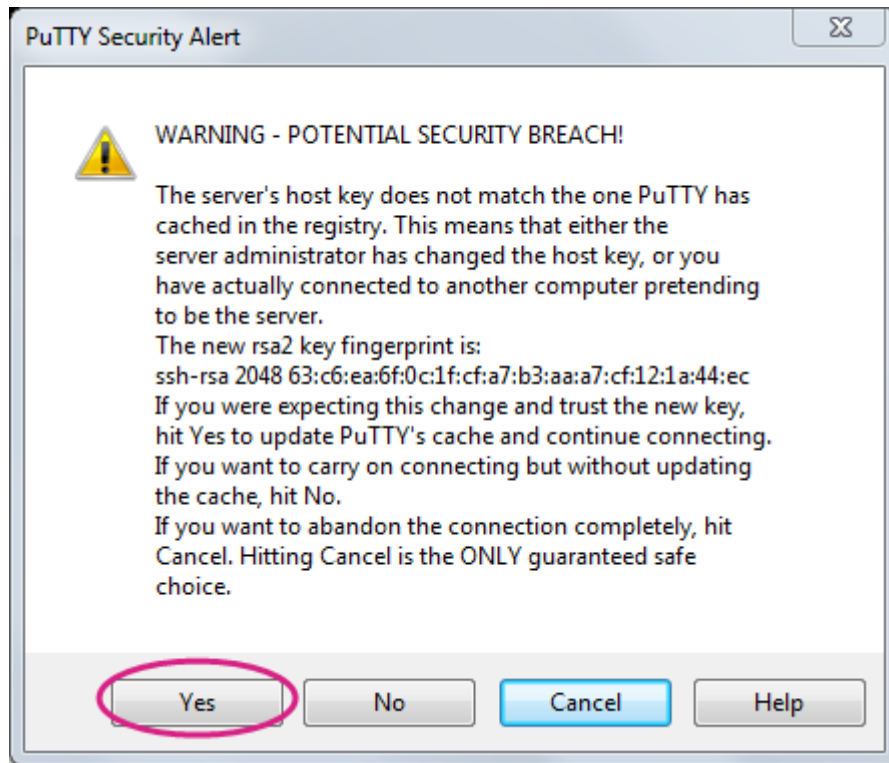

Figure 10 PuTTY Security Warning

- 3) The PuTTY terminal window displays. Log in with username **root** and the password you set previously in the Web UI, after log in you should see a screen similar to Figure 11.

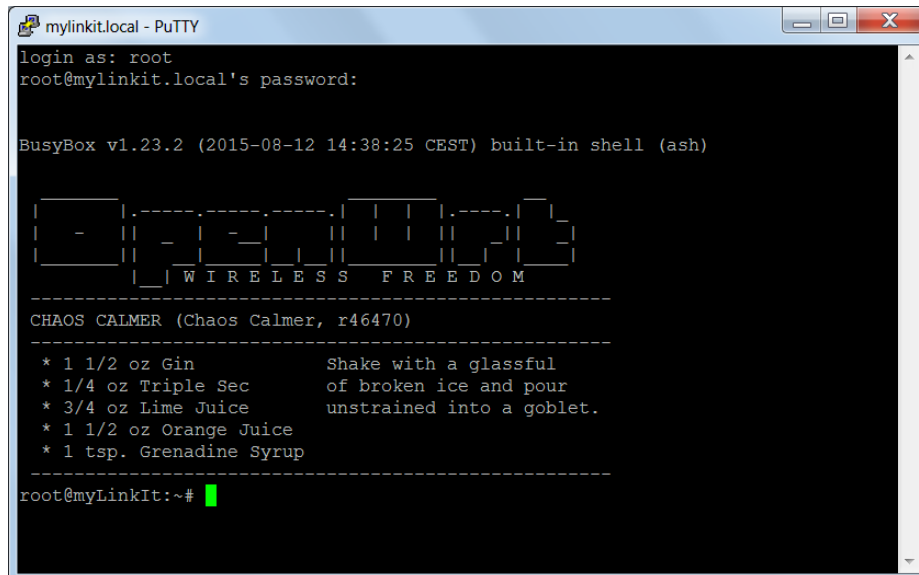

Figure 11 System console window

On Mac or Linux:

Open **Terminal** and at the command prompt type `ssh root@mylinkit.local`. Press return and enter the password you set previously in the Web UI.

If you see a warning error indicating host ID has changed, please check the Troubleshooting section in the MediaTek LinkIt Smart 7688 Developer's Guide.

You now have access to system console using SSH.

1.5. Run the Blink Example



You are now ready to run your first example on the LinkIt Smart 7688 development board. This example switches the board's Wi-Fi LED on and off every half second.

Quick steps:

- Execute the example in system console
- Watch the LED blink on the board
- Terminate the example

Next: Connecting to the Internet.

Step-by-step

Step 1: Run the blink example in LinkIt Smart 7688 system console

In the system console, type following command to run the blink example in Python:

```
# python /IoT/examples/blink-gpio44.py
```

Step 2: Watch the Wi-Fi LED blink

The Wi-Fi LED on LinkIt Smart 7688 should start to blink every half second.

Step 3: Terminate the blink example

In the system console, type **CTRL + C**, this will terminate the example.

You can now explore the system console and try other examples or Linux command utilities – but before that, it's important to connect the board to the Internet first. You can do that by connecting the board to a Wi-Fi Access Point that has Internet connection. The steps are described in the next section.

1.6. Connecting to the Internet



In order for the board to access the Internet, it needs to join another network that has an access point connected to the Internet, and to do that, the board needs to be in Station mode.

Quick steps:

- Connect LinkIt Smart 7688 to a Wi-Fi Access Point for Internet Access
- Connect the Host Computer to an AP that is in a Wi-Fi network
- Check for Internet connection

Next: What's Next?

Step-by-step

Step 1: Connecting LinkIt Smart 7688 to a Wi-Fi Access Point for Internet Access

- 1) Open a browser with URL `mylinkit.local`, and sign-in to the Web UI with the password you have set. Click **Network** on upper right as shown Figure 12.

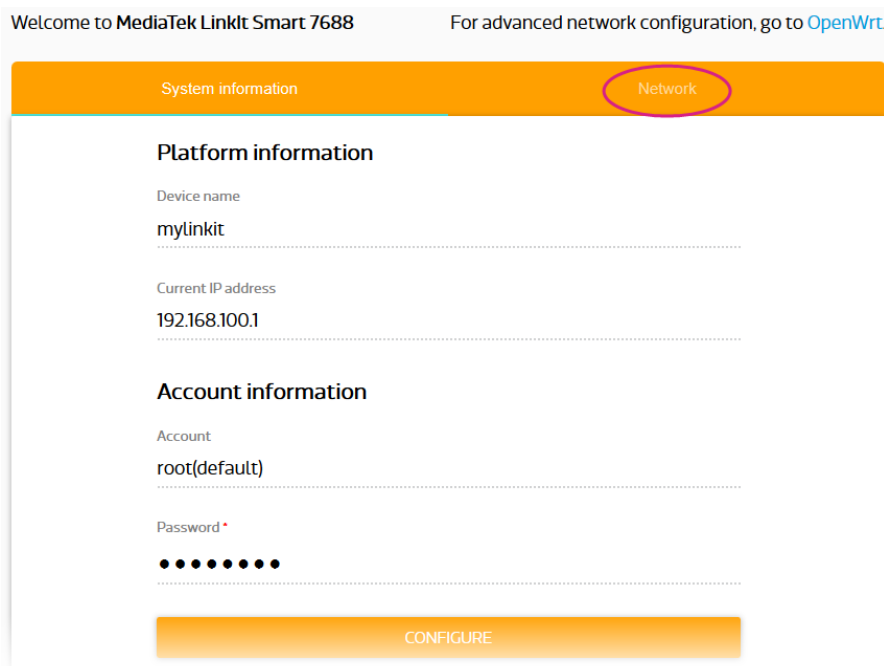

Figure 12 Change networking setting in Web UI

- 2) Select the **Station mode** and click **Refresh** or **downward arrow** on the right to find the AP to connect to. After you've selected the AP, enter password if required. Click **Configure & Restart** to finish as shown below.



Note: If you entered the AP's password incorrectly, you can reset the board to AP mode by clicking the Wi-Fi button for at least 5 seconds and release, this allows you to redo Station mode in the network settings again.

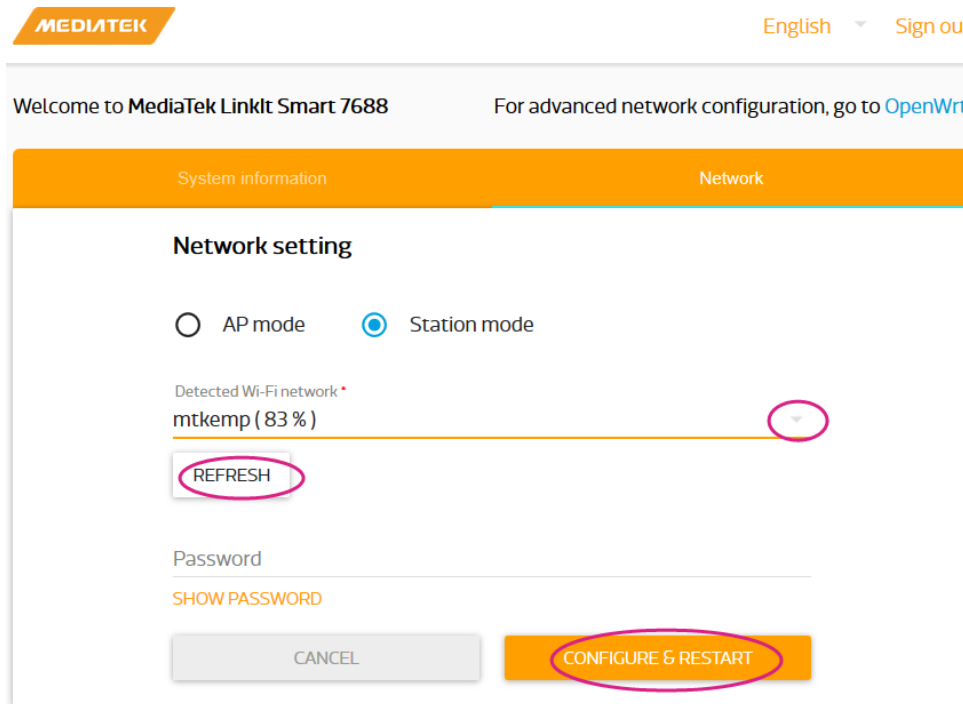

Figure 13 Changing to Station mode in Web UI

After you've switched to Station mode, the Wi-Fi LED should blink once a second, this indicates LinkIt Smart 7688 is in Station mode.

Since the Wi-Fi mode has changed, your host computer is now disconnected from LinkIt Smart 7688. If you try to reload the web UI, you'll see that it is not available anymore. To establish connection again, follow the next step.

Step2: Connect the host computer to the same AP

Open the Wi-Fi connection utility on your computer and connect to the same access point as in Step 1. Your computer is now under the same local area network formed by the Wi-Fi Access Point you connected to, as shown Figure 14.

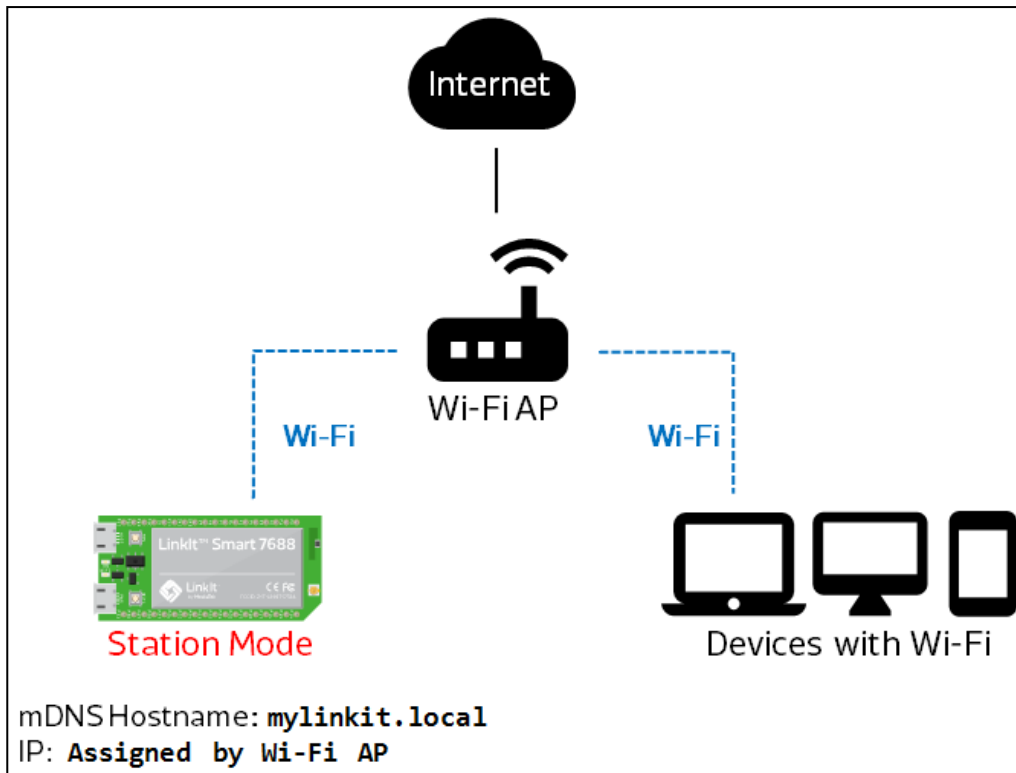

Figure 14 LinkIt Smart 7688 in Station Mode

Step3: Open terminal emulator and Sign in again

Once your host computer has joined the same Wi-Fi network, you can again connect to LinkIt Smart 7688 with mylinkit.local domain again through SSH as before.

Step 4: Check for Internet connection

Now check if you've established Internet connection by typing the following command in the terminal window:

```
# ping -c 5 www.mediatek.com
```

If you see a screen that is similar to Figure 15, then you've connected to the Wi-Fi network's AP. The Wi-Fi LED will blink once every second indicating Station mode. If the ping utility reports errors such as unreachable destination, check the setting of your Wireless AP.

```
root@myLinkIt:/# ping www.mediatek.com
PING www.mediatek.com (175.98.146.37): 56 data bytes
64 bytes from 175.98.146.37: seq=0 ttl=245 time=39.076 ms
64 bytes from 175.98.146.37: seq=1 ttl=245 time=38.717 ms
64 bytes from 175.98.146.37: seq=2 ttl=245 time=39.250 ms
64 bytes from 175.98.146.37: seq=3 ttl=245 time=118.304 ms
64 bytes from 175.98.146.37: seq=4 ttl=245 time=118.949 ms
```

Figure 15 LinkIt Smart 7688 in Station mode connected to a Wi-Fi AP

2. What's Next?



You've set up the development environment for LinkIt Smart 7688, ran an example using Python and connected the device to the Internet. Please check out more tutorials, resources and inspiration related to LinkIt Smart 7688 from the following links:

2.1. LinkIt Smart 7688 Developer's Guide

This document provides you with detailed information on the LinkIt Smart 7688 development board, SDT tools, introduction to OpenWrt and programming guide

2.2. LinkIt Smart 7688 Tutorials

The following tutorials are available:

- [LinkIt Smart 7688 & MediaTek Cloud Sandbox Python](#)
- [LinkIt Smart 7688 & MediaTek Cloud Sandbox Node.js](#)

2.3. Seed Studio Starter Tutorial

Create projects using LinkIt Smart 7688 applications for your LinkIt Smart 7688 HDK and see other Get Started Guide in Node.js

2.4. Hackster.io

See what other developers have created with LinkIt Smart 7688 and get inspired